



# Safe lifting / rigging loads Textbook

*That's what BLOM is all about!*





**KONECRANES**

CE 1996 NR  
BEDRIJESLAST

**KONECRANES**

VEILIGHEID  
[Safety diagrams and instructions]

**Michaël Kusters**  
las- en montageservice

**BLOM PLEIDING**

**ATLEY**

**STILL**

# Welcome to BLOM opleidingen

**We would like to wish you a warm welcome to this course on behalf of everyone at BLOM opleidingen. We hope that you enjoy this course. If you are satisfied, please do not hesitate to recommend BLOM courses to your colleagues and acquaintances!**

BLOM's training programmes and courses comply with the legal guidelines set out in the Working Conditions Act and are continuously adapted to the latest legal requirements, safety requirements and technological developments.

## Other BLOM courses

We offer a wide range of courses on:

- Material-handling equipment
- Aerial platforms
- Safe lifting
- First-aid VCA

For more information about these courses, please visit [www.blomopleidingen.nl](http://www.blomopleidingen.nl)

## Where to find BLOM opleidingen

BLOM training courses can be organised at modern, well-equipped locations throughout the Netherlands, while some courses are preferably given in-company.

For more information, registration, quote requests, administrative matters and questions, please contact us:

### **BLOM opleidingen**

Adam Smithstraat 41  
7559 SW Hengelo

**T** 074 - 376 40 44

**F** 074 - 376 49 99

**E** [info@blomopleidingen.nl](mailto:info@blomopleidingen.nl)

**I** [www.blomopleidingen.nl](http://www.blomopleidingen.nl)





**CAT**  
Lift Trucks

BLOM GREDINGEN



WIEL 3000 KG  
WIEL 3000 KG  
WIEL 3000 KG

# Textbook

## Safe lifting/rigging loads

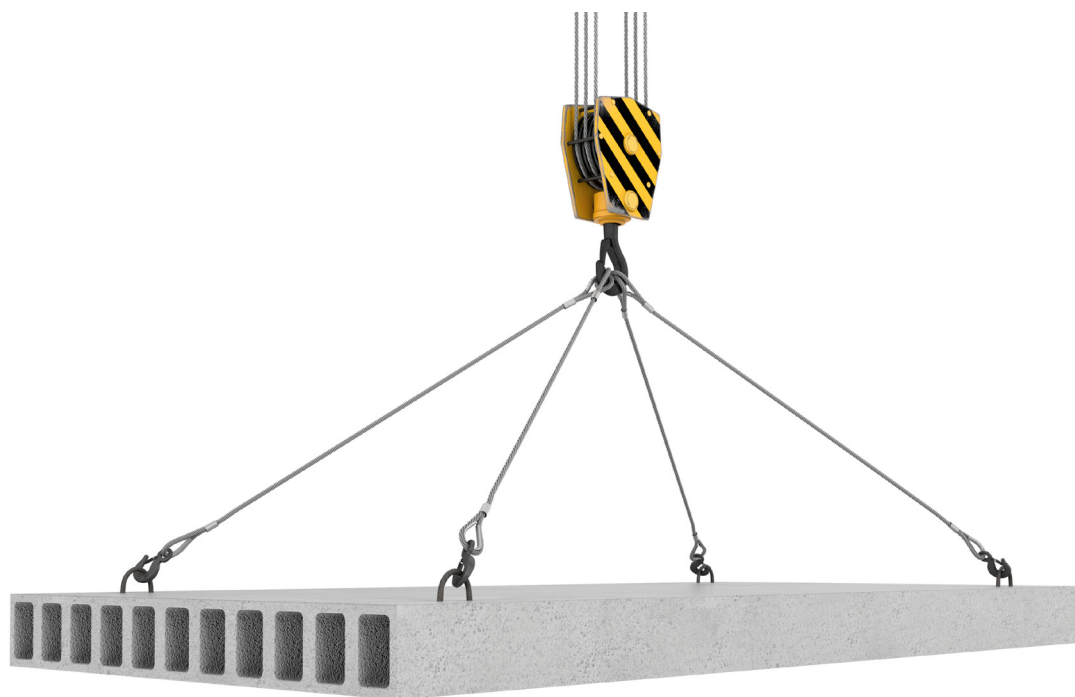

### **Textbook: Material-handling equipment training**

Author: R. Blommers  
Lay out: Limesquare

Edited by: R. Groothuis  
Published by: BLOM opleidingen  
Hengelo: january 2019

---

Publication number: BL2020-03-VHB

*All rights reserved. No part of this publication may be reproduced, stored in a retrieval system, or transmitted in any form or by any means, electronic, mechanical, photocopying, recording or otherwise, without the prior written permission of the publisher. The utmost care has been taken in compiling this course material, however, the publisher cannot be held responsible for any damage caused by the absence or incorrect inclusion of information in this course material.*



# Content

<b>1</b>	<b>Working Conditions Act</b>	<b>8</b>
1.1	Introduction	8
1.2	Structure of Occupational Health and Safety legislation	8
1.3	Health & Safety Data Sheets (HSD sheets)	8
1.4	Occupational Health and Safety Service	8
1.5	Inspectorate SZW	9
1.6	Rights and obligations	9
1.7	CE marking	10
1.8	Risk Inventory and Evaluation (RI&E)	10
<b>2</b>	<b>Lifting devices</b>	<b>12</b>
2.1	Introduction	12
2.2	Definition of safe lifting	12
2.3	Expertise	12
2.4	Crane information	12
2.5	Crane book	12
2.6	Hoist types	12
2.6.1	Stationary hoist	13
2.6.2	Monorail hoist	13
2.6.3	Overhead crane	13
2.6.4	Gantry crane	13
2.6.5	Wall-mounted jib crane	13
2.6.6	Column-mounted jib crane	13
2.6.7	Motorised and manual hoists	14
2.7	Technical safety devices	15
2.8	Limit switch	15
2.9	Attention points when using cranes	16



**3****Rigging equipment**

17

3.1	Introduction	17
3.2	Definition of rigging equipment	17
3.3	Basic requirements for rigging equipment	17
3.4	Certificates	17
3.5	Safety factor and break load	18
3.6	Influence of the sling angle	19
3.7	Chains	19
3.8	Chain types	20
3.9	Guidelines for using chains	21
3.10	Chain rejection criteria	22
3.11	Steel wire ropes	22
3.12	Guidelines for using wire ropes	24
3.13	Wire rope and choker rejection criteria	24
3.14	Web slings	24
3.15	Guidelines for the use of web slings	26
3.16	Flat web sling rejection criteria	26
3.17	Endless web sling rejection criteria	26
3.18	Fasteners	26
3.19	Guidelines for using fasteners	27
3.20	Fastener rejection criteria	27
3.21	Hooks	27
3.22	Eye bolts, eye nuts and lifting keys	27
3.23	Single-use eye nuts and eye bolts	28
3.24	Guidelines for using eye bolts and eye bolts	28
3.25	Tongs and clamps	30
3.26	Lifting magnets	30
3.27	Vacuum rigging equipment	31
3.28	Miscellaneous rigging equipment	31

**4****Lifting device and rigging equipment safety**

33

4.1	Introduction	33
4.2	Preparation	33
4.3	Rigging	33
4.4	Lifting	33
4.5	Landing	33
4.6	Rejecting lifting devices and rigging equipment	34
4.7	Communication	34
4.8	Hand and arm signals	35
4.9	Personal protective equipment	36



# Occupational Health and Safety Act

## 1.1

### Introduction

All employees are affected by working conditions, regardless of what work they do. Working conditions is an umbrella term for all matters related to health, safety and wellbeing at work. All measures taken to promote safety, health and wellbeing are based first and foremost on the Working Conditions Act.

## 1.2

### Structure of Working Conditions legislation

The Working Conditions Act is a framework and does not stipulate any specific rules. Rather, it contains a general description of duties and obligations relating to safety, health and wellbeing at work. The Working Conditions decree sets out the rules about the most common workplace risks in greater detail.

The Working Conditions Regulations contain even more detailed regulations on subjects such as the reporting of accidents, occupational diseases and occupational health and safety services.

*The core principle behind the Working Conditions Act is that employees and employers share responsibility for working conditions.*

## 1.3

### Occupational health and safety data sheets (AI sheets)

These so-called 'authoritative publications' are intended to flesh out the Act, but they do not belong to the Act themselves unless they are referred to explicitly in the Act.

Examples include:

- AI - 1 Occupational health and safety and absenteeism policy;
- AI - 11 Shielding and protecting machines;
- AI - 14 Business premises - layout, transport and storage;
- AI - 17 Rigging and lifting equipment and safe lifting.

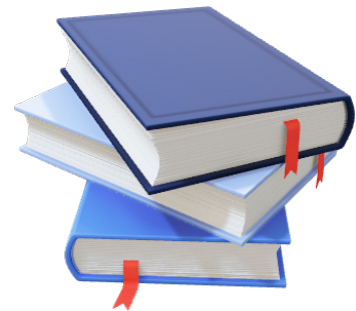

## 1.4

### Occupational Health and Safety service

Companies are no longer obliged to register with an Occupational Health & Safety (OHS) service, although it is still mandatory to seek expert support and advice, where necessary. This role can be played by an internal or external competent OHS expert.

This amendment to the Working Conditions Act is intended to give branches and companies more freedom of choice in the area of working conditions and absenteeism prevention. In order to guarantee the availability of absenteeism counselling and to give employees the opportunity to visit an OHS consultation hour, suitable arrangements must be made or a contract must be concluded with a registered occupational health physician.





## 1.5

### **Inspectorate SZWt**

The Inspectorate SZW falls under the purview of the Minister of Social Affairs and Employment and it informs, monitors, inspects and, if necessary, obliges employers and employees to improve their arrangements for health and safety. If an employee or employer violates the regulations, the Inspectorate SZW is authorised to impose a fine. In addition, the Inspectorate SZW stimulates consultation and coordination between employees and employers.

The Inspectorate SZW investigates the causes of accidents and advises the Minister on additional laws and/or policy regulations. Inspectorate SZW inspectors have the authority to impose an administrative fine if they establish that the Working Conditions Act has been violated. The Ministry of Social Affairs and Employment publishes an annual list of all violations and the associated fines, as part of their immediate-response policy (in Dutch: Lik-op-stuk-beleid), which has been in place since 1 November 1999.

## 1.6

### **Rights and obligations**

Employers must take measures to optimise their employees' safety, health and wellbeing and align this policy with all other policies in effect within the company.

### 1.6.1

#### **For employers**

Even though the Working Conditions Act is a list of general requirements, several clear obligations for employers arise from it:

- Employers must establish good working methods (through work instructions) and provide Personal Protective Equipment (PPE);
- Employers must ensure the workplace features escape routes and first-aid equipment;
- Employers must provide workers with adequate information on and training for the work they have to do;
- Priority must be given to new employees and the employees who are most at risk;
- Employers and employees must have regular meetings;
- Employers must, as far as possible, avoid giving employees monotonous, machine-based work (e.g. assembly line work);
- Employees must give employees the opportunity to maintain or improve their skills;
- Employers must adapt the situation at work (e.g. workplace layout or working methods) to their employees as much as possible;
- Employers must give employees as much freedom as possible in deciding how to do their work;
- Employers must take into account the personal characteristics of employees, such as age, education, experience and their physical and mental condition. In short: they have to make sure the right person is in the right position;
- Employers are obliged to describe their OHS policy and all risks present in their company in a RI&E. In addition, employers are obliged to describe all situations that do not meet the requirements set in the Act in an Action Plan;
- Depending on the nature of their company, employers must be assisted by one or more qualified Emergency Response Officers (EROs);
- Employers must implement an absenteeism policy.



## 1.6.2

### For employees

The Working Conditions Act also imposes various obligations on employees.

Employees also have various general obligations, such as:

- Employees must carry out the work in such a way that they do not endanger themselves or others;
- Employees must be familiar with procedures and instructions and act accordingly;
- Employees must use machines, equipment and the safety devices attached to them correctly;
- Employees are obliged to use personal protective equipment (such as a safety helmet, gloves, shoes and goggles) and to maintain it properly;
- Employees must participate in organised instruction and information sessions provided by the employer;
- Employees must report dangerous situations to the person in charge.

## 1.7

### CE - marking

On 1 July 1995, the European Union introduced a law to ensure that machines can be used safely. This law, the so-called Machinery Directive, lists a range of criteria that new products must meet. If a new product meets the requirements set out in this Machinery Directive, the manufacturer can affix CE marking to its product and issue a corresponding EC declaration of conformity. CE stands for Conformité Européenne. It is up to manufacturers to establish that the technical solutions they have developed meet the minimum requirements set out in the Machinery Directive. Products that pose serious risks, such as terminal tractors, require an official inspection report issued by an accredited inspection company.



## 1.8

### Risk Inventory & Evaluation (RI&E)

The rules specified in the Occupational Health & Safety Act are intended to ensure that employees can work safely and healthily in a pleasant atmosphere. All companies must draw up an Occupational Health & Safety (OHS) policy, indicating their arrangements for occupational health and safety and specifying whether they are willing to make funds available for this purpose. Working safely is often difficult in practice. There is always a chance that something will go wrong, and that is what we call risk. The definition of risk is as follows:

i

Risk is the degree of probability that a certain undesirable effect will occur.

**In summary: Risk = Opportunity x Effect**

The law requires employers to carry out a risk analysis, the so-called RI&E, with the assistance of one or more expert employees. If an employer does not have any or enough of these employees, external experts must be hired for this purpose.

This written analysis focuses on two main points:

- The degree of probability (the chance) that an accident will or could occur.
- The consequences of the accident, should it occur, in the short and/or long term.



During the risk analysis, the expert investigators identify the risks in the workplace and assess them on the following points:

- Nature of the work;

Office workers run different risks than transport workers.

- Training;

Employees without the right training are at greater risk than those with the right training.

- Workplace;

Employees must not be able to stumble or slip easily.

- Wellbeing;

Employees must be able to enjoy their work.

You have to know the risks before you can do something about them and reduce or even eliminate the risk of an accident. When an unacceptable risk is identified, employers must take measures, such as the following:

- Stop the work and provide instructions: in some cases, employees may be unaware that they are doing something wrong;
- Modifying the unsafe workplace;
- Training employees;

Providing proper instructions reduces the likelihood that an accident will happen, thereby reducing risk. Reducing risk is in the employer's and the employee's best interest, which is why the RI&E and the associated Action Plan must be known to the employees concerned.

---

i

**NOTE**

The Action Plan indicates what will be done to address any remaining problems and when this will happen.

Every year, a written evaluation must show whether the current workplace situation still corresponds to the RI&E and Action Plan. Because the RI&E is the source document for the OHS policy, it must be assessed by certified experts. Employees are permitted to do so themselves provided they have certified experts or an internal OHS service at their disposal. In other situations, they must call in external certified experts.

As of 1 April 2012, employees with a maximum of 25 employees need not have their RI&E document inspected, if they use a recognised RI&E instrument.

---

i

**NOTE**

Remember that there is a lot you can do to prevent accidents yourself. A good approach starts with assessing the risks that go along with your work.



# 2

## Lifting devices

### 2.1

#### Introduction

In this chapter, we will discuss the technical aspects of hoists. This information indicates the various criteria that hoists must meet, and we will also zoom in on the capabilities and limitations of different kinds of hoist, as well as how to best assess risks in practice.

### 2.2

#### Safe lifting

A hoist is a tool used to vertically move a freely suspended load.

### 2.3

#### Expertise

Users or operators of hoists must be at least 18 years of age. All operators using a hoist must have followed a suitable training course and must be familiar with all the rules and procedures on site.

#### Crane information

### 2.4

The information below can be found on the hoist. This information must be clearly legible.

#### i

- Manufacturer name
- Serial number model indication
- Year built
- CE marking
- Inspection sticker
- Maximum operating load

### 2.5

#### Crane book

All cranes weighing more than 2 tonnes must have a crane book. This crane book specifies the crane's design data, as well as information on commissioning, servicing and repairing the crane, along with a maintenance and repair log. It also contains the results of periodic crane inspections, which are required at least once a year.

### 2.6

#### Types of lifting devices

Lifting devices and lifting systems can be distinguished by structure and degree of freedom. Here is a list of the most common types.



**2.6.1****Stationary hoist**

Stationary hoists are suspended from a fixed point and can only move vertically.

Degree of freedom: lifting/lowering

**2.6.2****Monorail hoist**

Monorail hoists are mounted to a trolley that travels along a single beam, or monorail.

Degree of freedom: lifting/lowering  
trolley motion: left/right

**2.6.3****Overhead crane**

Overhead cranes permit various types of movement. First of all, the trolley can travel along the bridge, which in turn can travel along two tracks.

Degree of freedom: lifting/lowering  
trolley motion: left/right crane motion: forwards/backwards

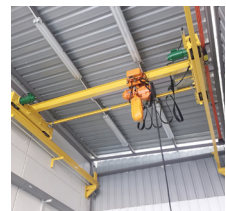
**2.6.4****Gantry crane**

Gantry cranes are similar to overhead cranes, but are supported on both sides of the bridge. These cranes are often used on open outdoor sites.

Degree of freedom: lifting/lowering  
trolley motion: left/right crane motion forwards/backwards (at right angles to the trolley) (rotation)

**2.6.5****Wall-mounted jib crane**

Column-mounted jib cranes have a trolley that can travel along the arm, of which one end is mounted to a rotating bracket attached to the wall. Wall-mounted jib cranes usually have a swivel range of up to 180°.

Degree of freedom: lifting/lowering  
trolley motion: left/right swivel: left/right

**2.6.6****Column-mounted jib crane**

Column-mounted jib cranes can be anchored to the floor virtually anywhere. Column-mounted jib cranes are virtually identical to wall-mounted jib cranes, but have a swivel range of up to 360°.

Degree of freedom: lifting/lowering  
trolley motion: left/right swivel: left/right



## 2.6.7

### Electric and manual hoists

Electric and manual hoists are a separate class of lifting devices, because they are both flexible and movable. These hoists are often indispensable aids for assembly and/or disassembly work.

There are two types of manual hoists:

Manual chain hoist



Lever hoist or pull lift



Because they have a drive, electric hoists cannot be used in exactly the same way as manual chain hoists, as they usually have two speeds: low and high. Electric motors usually feature fuses and thermal switches as overload protection.

A common risk involved with hoists is the problem of suspension. These portable lifting devices are often used in places without a fixed lifting system, which means they will have to be suspended from a fixture that may not have been intended for said purpose.

Always check the strength of this temporary, possibly one-off suspension point.



## 2.7

### Technical safety devices

#### Overload protection (OP)

Apart from a few exceptions, overload protection devices are mandatory on all pieces of lifting equipment with a charted capacity of 1000 kg or more. Overload protection devices shall never be used to help determine the load weight or to adjust the friction torque limiter.

i

Overload protection devices are mechanical devices that continuously compare the total load suspended from the hook with the maximum capacity of the lifting device.

#### Friction torque limiter

Electric hoists often feature a friction torque limiter as overload protection.

For cranes, the overload protection device must be set to a maximum of 110% of the charted load.

Torque limiters are housed in oil baths and brake linings are practically wear-free. Torque limiters are initially configured at the factory. If there is a suspicion that a torque limiter may not be working properly, it must be checked and/or adjusted by an expert using special tools.

#### Lever length

Manual hoists are not equipped with mechanical or electronic overload protection. Both the manual chain hoist (operated with a chain) and the lever hoist (operated with a lever) may only be operated manually by a single person. If this is not possible, the load is either too heavy or the hoist is due for a check-up.

i

#### NOTE

Extending the lever with a piece of pipe, for instance, is not permitted!

## 2.8

### Limit switch

#### On a crane

Limit switches safely limits the outermost positions of a crane. Limit switches must be triggered by means of a fault-free, mechanical actuator, which must be positioned such as to allow the crane to roll out sufficiently. This system should prevent the trolley and/or crane from colliding with the buffers at excessively high speeds.



### On a pulley block (anti-two-blocking device)

The lift is automatically halted when the pulley block is just below the trolley/lifting unit. This prevents the block from jamming the barrel, or the overload protection from being triggered unnecessarily. Limit switches can also restrict the downward travel of the cable, ensuring that the hook will never hit the ground. This prevents the cable from being unwound entirely, as it is important that three full wraps of cable remain on the drum! This may pose a problem when lowering a load into a basement.

### Proximity switch

When several cranes operate on the same track, they must not be able to collide during normal operation. This is prevented with a proximity switch, a sensor that will stop the cranes when they get too close to each other.

### Emergency stop

It must be possible to trigger an emergency stop from all operating positions. Emergency stops are intended to deactivate all moving parts of a crane.

## 2.9

### Points of attention for safe crane operation

In practice, lifting devices must be inspected periodically (at least once a year). The purpose of this inspection is to ensure that lifting devices are safe and suitable for use. Despite the fact that most accidents occur as a result of incompetent use or overloading, it is still important to take the following technical instructions into account: Only work with inspected and approved lifting devices. Check the inspection sticker or consult the crane book if necessary.

Before using a lifting devices, check the following:

- Check that the emergency stop is functioning properly;
- Check that the crane's normal travel modes are functioning properly, such as lifting, lowering and trolley & crane travel.
- Check that the brakes are functioning properly (lifting & travel brakes);
- Check the wire rope or chain for wear or defects;
- Check the load hook for defects;
- Check that the proximity switches are functioning properly, when working with multiple cranes on a single track;
- Never exceed the maximum permitted working load;
- Never leave a lifting device with a suspended load unattended;
- After use, it is preferable to return cranes back to a parking point.

When a crane is not in use, lift the load block to a height at which it will not form an obstacle for any passers-by, including trucks and forklifts. Do not leave the pendant control unit hanging in the middle of an aisle. Return the remote control to a fixed, agreed location.

Furthermore: only persons aged 18 and over, who have been properly trained and who have been authorised by the company may operate or assist in operating a lifting device.





# Rigging equipment

## 3.1

### Introduction

You need more than a crane to lift loads: you also need rigging equipment. Any rigging equipment you use must be suitable for the job at hand, including chains, wire rope, web slings, fasteners, eyebolts, and so on.

## 3.2

### Definition: rigging equipment

Rigging equipment is used to connect the load to be moved with the lifting device.

## 3.3

### Basic requirements for rigging equipment

To prevent overloading the rigging equipment, it is important to observe the work load limit indicated on the rigging equipment. This Work Load Limit, or WLL, is expressed in kilograms (kg) or tonnes (t).

You can find the following information on all rigging equipment. This information must be clearly legible.

- The Work Load Limit (WLL);
- Unique number (certificate);
- Date of last inspection (year colour);
- Own weight over 100 kg (OW);
- CE marking.

In addition, chains and web slings have the following:

- The manufacturer's label;
- An indication of the material quality;
- Rigging methods.

## 3.4

### Certificates

All lifting equipment must be accompanied by a certificate, containing information such as its work load limit, material, dimensions and the date of the last inspection. Because all certificates are numbered, just as the equipment in question, certificates cannot be used for multiple pieces of equipment. These certificates must be in the vicinity of the job site, but when working in changing locations - as with assembly work - a list of all present lifting equipment will suffice, provided that the certificates in question are available/retrievable.

Section 7.20 of the Working Conditions Decree states that lifting equipment must be subjected to an examination to ensure that it is in good condition, testing it if necessary. There is a defined difference between inspections and approval testing (see table).

The check-up row has been added to emphasise the fact that operators must always check their equipment prior to use.

Description	When	Person	Level	Proof
<b>Approval testing</b>	Upon delivery	Structure-level expert	Measurement / test load	IIA declaration
<b>Check-up</b>	Prior to use	User	Visually check condition and capacity	No
<b>Inspection</b>	At least once a year	Expert (higher than user level)	Rating/ measurement	Yes, used for rating
<b>Rating</b>	Depends on usage according to expert or manufacturer recommendations	Structure-level expert	Measurement / test load	Yes, specifying measurement data and/or test load

### 3.5

#### **Safety factor and break load**

Because lifting equipment is exposed to wear and tear in practice and because it may unintentionally be exposed to temporary overloading due to shock loads, it is made stronger than theoretically necessary. The difference between the actual capacity and the permitted capacity of lifting equipment is known as the safety factor, safety coefficient or factor of safety.

In short, the safety factor is used by manufacturers to limit breakage in real-life situations as much as possible. Different types of equipment have different safety factors.

Lifting chains have a safety factor of 4, steel wire ropes have a safety factor of 5 and web slings have a safety factor of 7.

i

#### Definition of the safety factor

The safety factor is the ratio between the work limit load and the break load.

i

#### Definition of break load

The break load is the level of stress at which the equipment breaks when tested on a tensile testing machine.

Remember not to take the safety factor into account when assessing whether a situation is acceptable or not. It should serve only as an extra element of protection for emergency situations. There is no such thing as the ideal situation. Many mistakes, errors and defects remain more or less hidden and can therefore not be taken into account, but they are mitigated by the safety factor.



### 3.6

#### Influence of the sling angle

With some types of rigging equipment, parts of the equipment will be at an angle, e.g. two, three and four-leg rigging). The angle between the parts of a sling is called the “sling angle”. As the angle between the parts increases, the load increases too.

To clarify the difference between the vertical angle and the sling angle, please see the drawings:

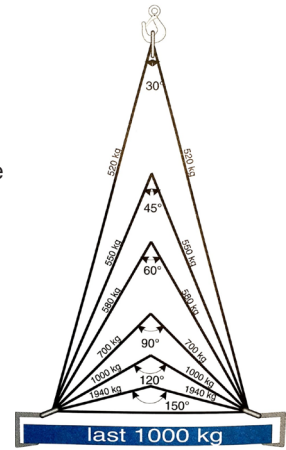

#### CAUTION

The maximum permitted vertical angle is 60°.

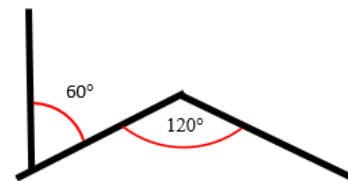
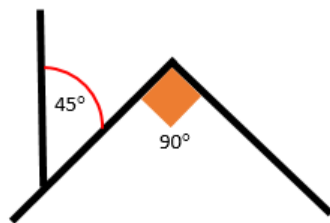

45° vertical angle equals 90° sling angle, 60° vertical angle equals 120° sling angle.

You will find the vertical angle specified on chains and web slings. To simplify matters, you will only find 45° and 60° vertical angles.

### 3.7

#### Chains

Only short-link chains with an inner link length no greater than 3xd (link width) may be used as rigging equipment. Chains are very-resistant and therefore suitable for heavy-duty work.

Chains have a safety factor of 4.

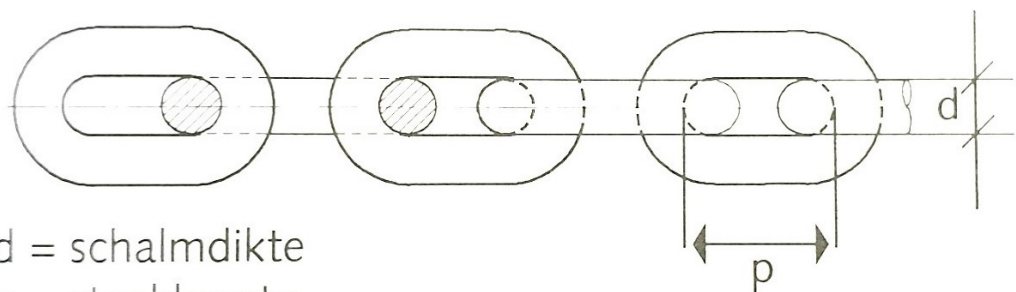

d = schalmdikte  
p = steeklengte

### 3.8

#### Chain types

##### Choker chains (choker hitch)

Choker chains have a master link (oblong or pear-shaped) on both ends. These chains can be used to make a choker hitch.

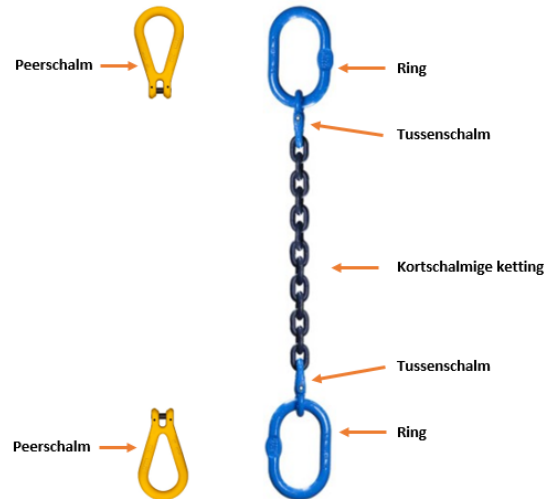

##### Hooked chains

Hooked chains have a master link (oblong or pear-shaped) on one end and a hook on the other end. These chains cannot be used to make a choker hitch. Hooked chains are often used to connect a crane hook to a load.

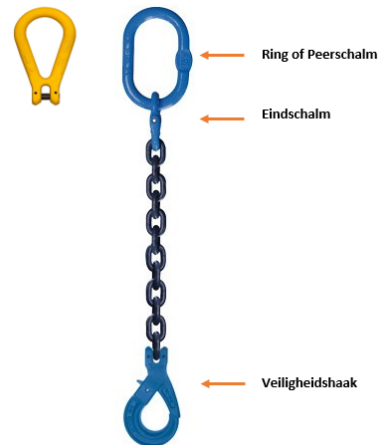

##### Two-, three- and four-leg rigs

When using a two-, three-, or four-leg rig, pay attention to the load per chain. When using a four-leg rig, there is a risk of uneven loading - the load factor is equal to that of a three-leg rig. At 0°/45° the factor is 2.1, at 45°/60° the factor is 1.5.





Hooked chains with 10 mm links have a WLL of 3.15 tonnes.

A four-leg rig with the same diameter has a WLL of 6.7 tonnes at 45° and a WLL of 4.75 tonnes at 60°. This is because the load is distributed over the various chains. Three- and four-leg rigs are considered identical, so the example below is based on a three-leg rig.

At 0°/ 45° the factor is 2.1 (3 x 0.7)                      2.1 x 3.15 = 6.7 Tonnes  
 At 0°/ 45° the factor is 1.5 (3 x 0.5)                      1.5 x 3.15 = 4.75 Tonnes

Turning a four-leg rig into a two-leg rig, with two chains hooking into the master link, clearly reduces the WLL:

At 0°/ 45° the factor is 1.4 (2 x 0.7)                      1.4 x 3.15 = 4.25 Tonnes  
 At 0°/ 45° the factor is 1.0 (2 x 0.5)                      1.0 x 3.15 = 3.15 Tonnes

### 3.9

#### Guidelines for using chains

- Chain legs may only be shortened with suitable grab hooks or shortening clutches.
- When lengthening chains, only use coupling links with the same strength and only use chains with the same strength/quality;
- When lifting loads, remember that the WLL is reduced at high and low temperatures;
- Do not use alloy steel chains at temperatures below -40°C and above +200°C; Special guidelines apply beyond these temperatures. For more information, please consult the instruction manual;
- Do not use alloy steel chains with pickling tanks;
- When using a two-, three-, or four-leg chain sling, the hooks of any unused legs must be hooked into the master link;
- Make sure that the sling angle is always smaller than 120°, even when using chokers;
- Chains may not be extended or shortened by tying knots or using nuts and bolts;
- When used vertically, chains may be subjected to 100% of the WLL;
- Chains used in chokers can be subjected to 80% of the WLL;
- When using chains over sharp rounded edge, other reduction factors apply. For more information, please consult the operating instructions.

### 3.10

#### Chain rejection criteria

- Unknown work load limit;
- Each part of the assembly is 10% worn;
- The chain is damaged (nicks and cracks);
- The chain is deformed;
- The chain shows discolouration (possibly due to heating).



#### CAUTION

Pay special attention to the pins used in the connections! Always follow the manufacturer's rejection criteria, as found in the operating instructions.

### 3.11

#### Steel wire ropes

Steel wire ropes are a moderately wear-resistant type of rigging equipment, because the wires are very hard. The advantage of using steel wire rope over a chain is its narrow diameter and lower weight at the same WLL. Steel wire ropes are also more elastic than chains and therefore more capable of absorbing shocks. On top of that, it is much easier to slide wire ropes under a load. They are sensitive to damage, but not as sensitive to contamination. Wire ropes can be used as a choker or grommet. Wire ropes are compatible with various types of end fittings (talurit sleeves, superloop, splices).

Steel wire ropes consist of several bundles of thin steel wires, known as strands. These strands are wrapped around a core. The number of strands and wires determines the structure of the steel wire rope. The core can be a steel cable or rope. The wire rope's structure will determine its properties. Steel wire rope has a safety factor of 5.

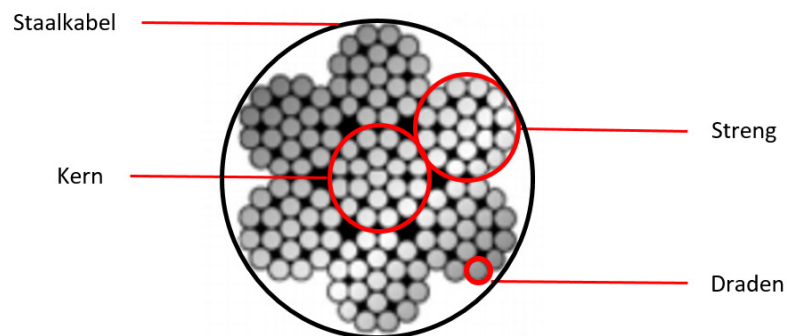

### Talurit end fittings

Talurit sleeves consist of a light metal clamp that is pressed around the cable. The end of the cable must protrude visibly from the clamp. The sleeve should not be damaged, and a major disadvantage of this type of end fitting is that it is very sensitive to bending loads.



### Superloop

A superloop is a high-quality splice, which can be recognised by a steel ferrule that tapers around the end fitting.



### Spelter socket

Spelter sockets are the safest type of end fitting. If carried out correctly, this will not reduce the WLL of the hitch compared to the wire rope's original WLL.

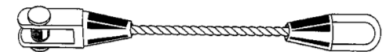

### Steel wire rope slings and multi-leg assemblies

Some steel wire slings consist of a wire rope with two thimble eyes, whereas other steel wire slings have one end that can be hitched to a load.

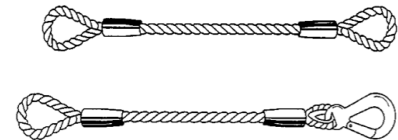

### Multi-leg rigs

Rigging assemblies in which one or more steel wire rope slings are attached to a single link are called multi-leg assemblies. We distinguish between two-, three-, and four-leg assemblies.

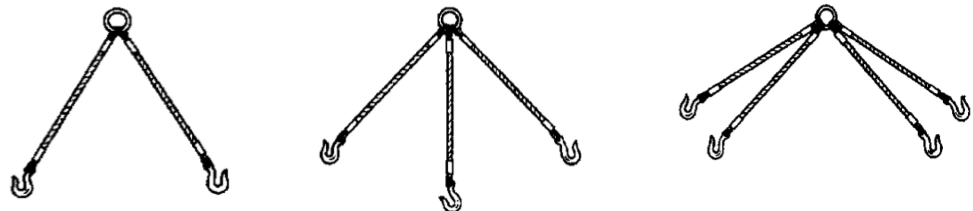

## Defective steel wire ropes

### Wear and tear on steel wire ropes

When used, all wire ropes are subject to internal and external wear and tear. You assess the general condition of wire rope on the basis of external (visible) wear and tear.

### Corrosion

Moisture and other contaminants may corrode steel wire rope. You can delay corrosion by greasing/lubricating steel wire ropes, but it can never be prevented entirely. Grease wire ropes immediately after purchase. If you use them before greasing them, you will only be encapsulating the dirt, which will form an abrasive layer around the wire rope. It is important that you check steel wire ropes for corrosion regularly, bearing in mind that steel wire ropes also corrode from the inside. Do not use any steel wire ropes that look rusty, not even if they are only partially corroded.

### Wire breakage / core breakage

Wire breakage and core breakage can occur due to fatigue failure and wear & tear, even during normal use. Damage is usually the result of improper use. Contact between wire ropes and rough surfaces may lead to abrasions, for instance, or slings may have been in contact with sharp edges. Internal wire breaks are usually difficult to detect. You can try to find them by cleaning and bending the cable in the spots where you suspect the wires may be broken. Strand breaks or breaks between the strands and the core are very difficult to detect, which is why it can be very hard to assess the condition of a steel wire rope. When in doubt, do not use the wire rope.

### Wire rope deformation

Wire rope slings may start to deform when stretched over a rounded edge less than 6x the diameter of the rope. When wire rope slings are deformed to the extent that the cable core can be seen to emerge through the strands, they must be rejected. Consult the user manual or an expert.

## 3.12

### Guidelines for using wire ropes

- Wear safety gloves to prevent injuries due to protruding wires (so-called meat hooks);
- When using wire rope slings as a choker or basket, ensure the top angle stays less than 120°;
- Do not extend or shorten wire ropes by tying knots or using nuts and bolts;
- Swage sleeves may not be subjected to bending loads (at angles greater than 60°). These sleeves may not be damaged either.

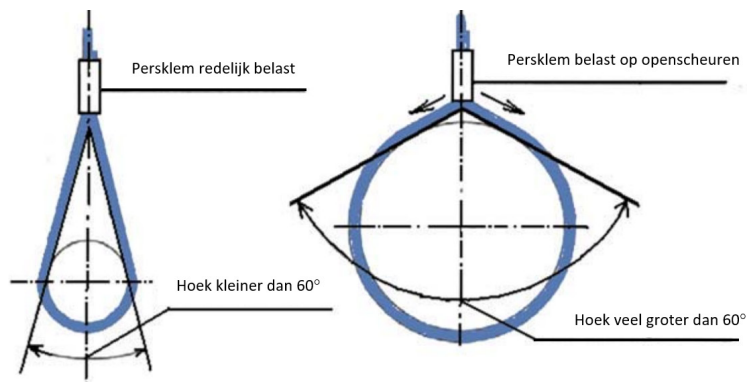

## 3.13

### Wire rope rejection criteria

- Unknown work load limit;
- The end fitting is damaged;
- The cable end is no longer visible (talurit sleeve only);
- Excessive corrosion;
- Cable deformation;
- Multiple wire breaks;
- The cable has been flattened to 1/3 of its original diameter;
- There is no declaration of conformity (certificate) available.

## 3.14

### Web slings

Synthetic web slings are soft, so as not to damage the load. Synthetic web slings are sensitive to wear & tear, damage and contamination (be mindful when using in combination with sharp-edged loads). Always use softeners or corner protectors to prevent damage. Web slings have a safety factor of 7.





### Flat web slings

Flat web slings are made of a length of synthetic webbing and feature stitched loops at both ends. When working with flat slings with loops, special attention must be paid to the loops. The loops may not be subjected to tensile stress to the point that they can open up (no more than 20° according to the manufacturer). The loop is the most critical part of the sling.

Carefully check the stitching prior to use.



### Round slings

Round web slings are made from a synthetic material and protected by an outer sleeve. This sleeve does not add to or diminish a sling's strength and has the disadvantage that the sling's core cannot be inspected.

If the outer sleeve of a round sling is damaged, it can be assumed that the inside is also damaged.



Web slings come in different colours, which indicate their WLL. However, the WLL indicated on the label is always final! Slings are also marked with one or more longitudinal lines, with each line representing 1 tonne. However, the WLL specified on the label is always final. The label also specifies which rigging method should be used.

#### Stress table

Colour code in accordance with EN 1492	max. WLL with 1 web sling or choker sling						max. WLL with 2 web slings or choker slings					
	Single	Choke	0°		7°		45°		7°		45°	
			up to 7°	up to 45°	up to 60°	up to 45°	up to 60°	up to 45°	up to 60°			
<b>factor</b>	<b>1.0</b>	<b>0.8</b>	<b>2.0</b>	<b>1.4</b>	<b>1.0</b>	<b>0.7</b>	<b>0.5</b>	<b>1.4</b>	<b>1.12</b>	<b>1.0</b>	<b>0.8</b>	
WLL 1 t	1.000	800	2.000	1.400	1.000	700	500	1.400	1.120	1.000	800	
WLL 2 t	2.000	1.600	4.000	2.800	2.000	1.400	1.000	2.800	2.240	2.000	1.600	
WLL 3 t	3.000	2.400	6.000	4.200	3.000	2.100	1.500	4.200	3.360	3.000	2.400	
WLL 4 t	4.000	3.200	8.000	5.600	4.000	2.800	2.000	5.600	4.480	4.000	3.200	
WLL 5 t	5.000	4.000	10.000	7.000	5.000	3.500	2.500	7.000	5.600	5.000	4.000	
WLL 6 t	6.000	4.800	12.000	8.400	6.000	4.200	3.000	8.400	6.720	6.000	4.800	
WLL 8 t	8.000	6.400	16.000	11.200	8.000	5.600	4.000	11.200	8.960	8.000	6.400	
WLL 10 t	10.000	8.000	20.000	14.000	10.000	7.000	5.000	14.000	11.200	10.000	8.000	

### 3.15

#### **Guidelines for the use of web slings**

- When rigging sharp-edged loads, always use softeners (e.g. rubber spacers) or special coated or protected slings. Web slings can be subjected to loads up to 100% of the WLL if the rounded surface around which they are applied is larger than twice the thickness of the sling. If the rounded surface is less than 2x as thick as the sling, the WLL of the sling must be reduced to 80%;
- Web slings must be attached to lifting hooks in such a way that the loop is flat, cannot deform or constrict and cannot be damaged by sharp edges. Flat web slings without reinforced loops may not be used as chokers. When using chokers, ensure that the top angle stays less than 120°;
- Web slings may not be lengthened or shortened by tying knots and may not be used to lift loads when twisted;
- Do not use web slings below -40° or above +100°C. Be mindful of damage caused by welding spatter, etc. If you find holes in the protective cover of an endless web sling, it must be rejected;
- Do not expose web slings to excessive abrasion;
- When using multi-leg assemblies (a 2-, 3-, or 4- leg assembly) the hooks of unused legs must be connected to the master link;
- Broken stitching often indicates overloading. Rejection criteria;
- When using web slings, the loops may not open at an angle greater than 30° to prevent the stitching from ripping;
- You can also use single-use web slings, which are marked as such. These slings may only be used a single time;
- Avoid forced drying. Preferably, hang web slings in a well-ventilated area and protect them from bright sunlight.

### 3.16

#### **Flat web sling rejection criteria**

- Unknown work load limit;
- Identification no longer possible (label is illegible or missing);
- The web sling has cuts or friction damage;
- The loop is damaged (worn loop, loose stitching);
- Knots;
- Extreme soling

### 3.17

#### **Endless web sling rejection criteria**

- Unknown work load limit;
- Identification no longer possible (label is illegible or missing);
- Damaged outer sleeve (inner core visible);
- Knots;
- There are burn holes in the outer sleeve.

### 3.18

#### **Fasteners**

Each fastener has its own application. The wide shape of the bracket on an H fastener makes it possible to connect it to several fasteners, rings or chokers. If fasteners are used in places out of the operator's sight, they must always be fitted with a through bolt with a nut and split pin. Split pins are used to secure the nut and stop it from loosening. Fasteners may not be subjected to operations that may affect their strength, such as grinding and welding.



### 3.19

#### Guidelines for using fasteners

- Fasteners may only be loaded from the appropriate angle;
- Fasteners should not get stuck during lifts;
- Fasteners must fit and be loaded properly;
- Fasteners must be subjected to limited lateral stress.

### 3.20

#### Fastener rejection criteria

- Unknown work load limit;
- The pin/diameter is 10% worn;
- The fastener is damaged (nicks and cracks);
- The fastener is deformed;
- The original pin is missing;
- The chain shows discolouration (possibly due to heating).

### 3.21

#### Hooks

Hooks must be fitted with a device to prevent unintentional unhooking. Under special circumstances, e.g. in foundries, open hooks are permitted, provided such applications are stated on the certificate and in the operation instructions.

Hooks should never be hooked into lifting eyes of the wrong size, to prevent the hook from being subjected to a point load. Hooks must also be able to move freely, so that no lateral forces can occur. Hooks should always be attached from the inside out.

Hooks designed as straight DIN hooks (the hook attached to the crane) may only be subjected to vertical loads. For rejection criteria, see the fastener standards.



### 3.22

#### Eye bolts, eye nuts and lifting keys

Machines and loads may have integrated eye bolts and eye nuts, but they can also be used separately. Eye bolts, eye nuts and lifting keys are considered chainwork and their WLL must be stated on the material in question.



### 3.23

#### Single-use eye nuts and eye bolts

Some manufacturers apply single-use eye nuts and eye bolts to their products to lift them prior to assembly. In other words, these fasteners are used once, when being transported from the supplier to the construction site. After disassembly, these lifting eyes may no longer be used. Usually, these are C15 eye bolts or eye nuts, which may be made of age-sensitive materials. Manufacturers are obliged to specify how the machine or machine part in question should be lifted. On top of that C15 eye bolts or eye nuts do not always state their WLL. In that case, please refer to the appropriate load table.

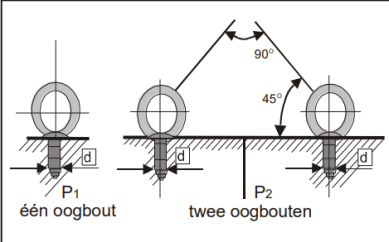

d metrisch	St 34		C15N	
	één oogbout P1 in kg	2 oogbouten P2 in kg	één oogbout P1 in kg	2 oogbouten P2 in kg
M10	85	—	230	170
M12	220	—	340	240
M18	380	—	700	500
M20	570	—	1200	830
M24	1050	1000	1800	1270
M30	1700	1800	3500	2600
M38	2500	2600	5100	3700
M42x3	3400	3800	7000	5000
M48x3	5200	5200	8500	6100
M55x4	6500	6500	11500	8300
M64x4	8700	8400	18000	11000

### 3.24

#### Guidelines for the use of eye bolts and eye nuts

- Eye bolts and eye nuts must always be fully tightened. Bolts or nuts must fit snugly;
- Never lift with a sling angle greater than 90°. Remember that this can reduce the total load capacity. The WLL of an eye bolt is determined by the thread and the top angle. This information can be found in the WLL table for the bolt;
- Pay attention to the thread of the eye bolt or eye nut. The thread may not be worn. The load must feature the same thread, and this thread must also be flawless.
- Do not subject straight eye bolts or nuts at an angle of more than 90° in the direction of the bolt.

For rejection criteria, see the fastener standards.

### 3.25

#### Tongs and clamps

Tongs and clamps refer to all rigging equipment that is used to lift loads by clamping it between claws or clamping surfaces. These claws or clamping surfaces are designed in such a way that they stay in place because of the weight of the load. In this case, the pull force is caused by friction. These clamps are designed for vertical transport of sheet material, for instance.

Clamps with vertical clamping surfaces (during normal use) shall be equipped with an automatic locking device. This device must ensure that the clamping surfaces stay clamped against the load, so that the load is not accidentally released as the result of a collision or after landing.



Clamps intended to move more than one object at a time must be fitted with a device (fall arrest device) that prevents a load or parts of a load sliding out of the clamping surfaces.



i

#### Examples

- Lifting clamps used for bricks or blocks usually feature a net to prevent the load from falling down.
- Floor clamps often feature a chain or similar device under the load to prevent the load from falling down.



As the drawing of this plate clamp shows, the clamp's lifting capacity will decrease when used at an angle.

A set of two clamps is usually used to transport plates horizontally. The clamps are then attached to the middle of the plate, on opposite sides.

The upper ring can be attached to the hook of the crane. When the chain is tightened, the hinged jaws of the plate clamp are pressed down, thus clamping the load. Because chain links will also be subjected to bending loads in this case, the sling angle should never exceed 60°.

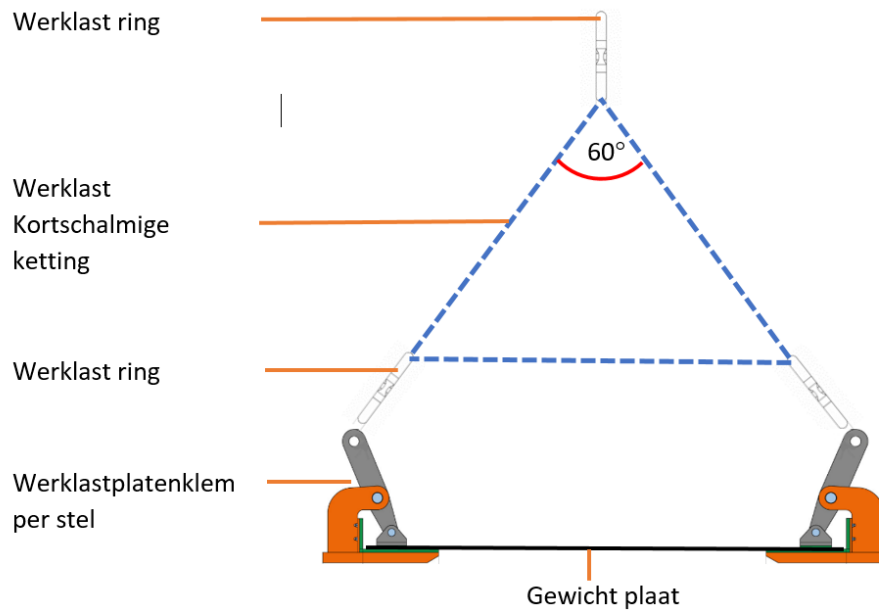

### 3.26

#### Lifting magnets

Lifting magnets can either be permanent magnets or electromagnets. Lifting magnets are only suitable for lifting loads made of iron or steel. The pull force of a magnet depends strongly on the thickness and shape of the load. The ductility of the load also plays a major part, as parts of it may bend. The nature and condition of the surface of the load and the magnet (effective interface). Because the interface between the magnet and the load should be as horizontal as possible, magnets have a limited range of applications.

The main advantage of using magnets is that they are unlikely to damage a load. On top of that, it is very quick and easy to rig and detach loads with a magnet, and it can be done remotely. A key disadvantage of magnets is that their pull force cannot be measured and that it can decrease during a lift, e.g. as a result of shock loads. Lifting magnets must be inspected annually. The strength of the magnet must be tested.

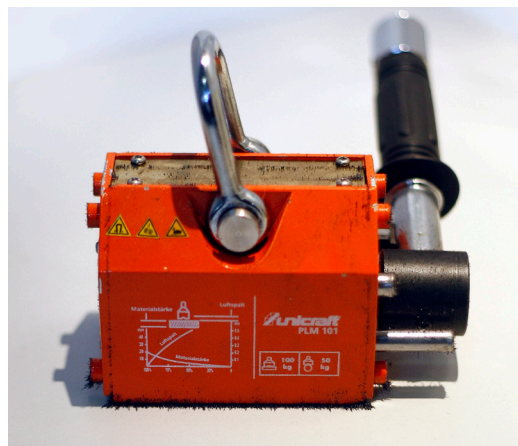

### 3.27

#### Vacuum rigging equipment

Vacuum rigging equipment uses air pressure, or more specifically negative pressure, to lift loads. You can lift loads by extracting air. The principle of vacuum lifting revolves around a single concept: negative pressure.

Negative pressure occurs when the air pressure in a certain space is lower than in the area around it. You can lift a load with a suction cup by extracting the air from, or creating a vacuum in the space under the suction cup. We have now created negative pressure. The suction cup will cling to the load and remain fixed as long as there is negative pressure.

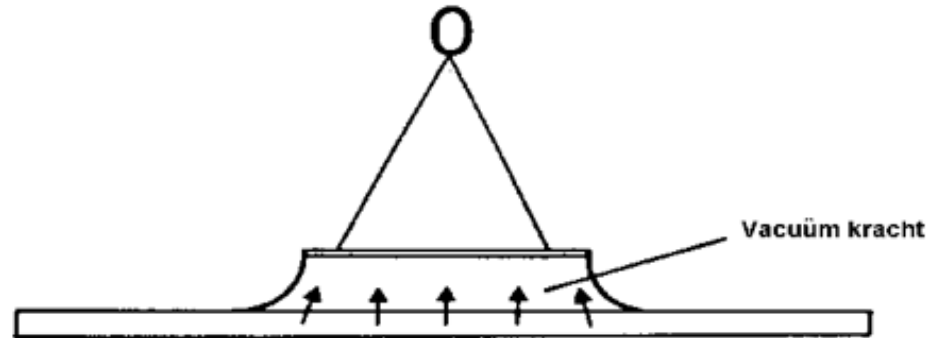

Vacuum rigging equipment is suitable for lifting loads that do not have overly porous, smooth, flat or cylindrical surfaces. The pull force of such equipment depends on the presence of a constant vacuum, as any air leakage can cause the equipment to release and drop the load within seconds. The position of a suction cup, for instance, is also a key factor in determining its pull force. Suction cups should be positioned as horizontally as possible. When positioned vertically, the pull force of a suction cup is reduced by approximately 50%. On construction sites, vacuum rigging assemblies must always have a redundant counterpart or feature a fall protection device. Vacuum rigging equipment must be rated every year and inspected every three months!

### 3.28 Miscellaneous rigging equipment

#### C-hook

C-hooks are used to lift roles and pipes, such as sewer pipes. C-hooks should be attached directly to the load. When lifting the specific load for which they were designed, these hooks should be inclined backwards by about 5°. Some C-hooks have a self-adjusting rigging point, whereas others feature a counterweight.

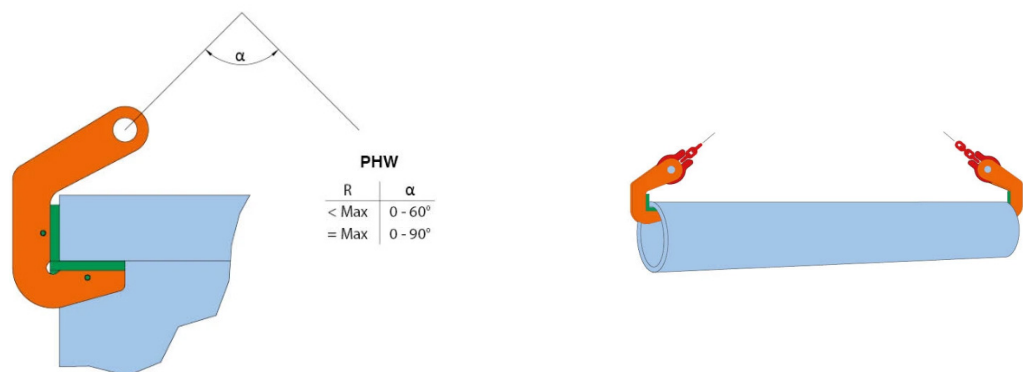

### Pallet hook

The pallet hook is a special version of the C-hook that is used to lift pallets. When lifting loosely stacked loads, the load must be secured with a net or strap so that it cannot fall.



### Traverse, lifting yoke or spreader

Lifting yokes are used to lift very large or very heavy loads and feature several rigging or support points. This type of equipment is used to lift massive diesel engines for ships, for instance. Lifting yokes, when loaded, must always hang horizontally. When using slings, these must hang vertically.



### One-way rigging equipment

One-way rigging equipment may only be used once, as the name suggests, and may not be removed or attached during transport. After use, one-way rigging equipment such as fasteners, eye bolts, eye nuts, lifting slings and big bags must be taken out of service. Single-use or one-way rigging equipment has a safety factor of 5.

### Custom-made rigging equipment

Custom-made rigging equipment must also comply with the Machinery Directive. Manufacturers of custom-made rigging equipment will have to declare that the equipment complies with all provisions of the Machinery Directive. All equipment must be provided with an indication of its Work Load Limit (WLL), CE marking and operating instructions. Custom-made rigging equipment should preferably be rated and tested by a specialist rating agency. After approval, they can issue a certificate that can be used by the supplier in their declaration of conformity.





# 4

## Lifting device and rigging equipment safety

### 4.1

#### Introduction

To work safely with lifting devices and rigging equipment, several preliminary steps must be taken. You have to prepare for the lift, rig the load, lift the load and land the load.

### 4.2

#### Preparation

During preparation, consider the following:

- What does the load look like;
- What does the load weigh;
- Where are the rigging points;
- Do I have the right lifting equipment;
- Do I have a clear view of the entire lift;
- How should the load be landed;
- What is the weather like (dry, wet, windy, frost, etc.).



#### CAUTION

Do not lift loads at wind speeds exceeding 39 km/h!

### 4.3

#### Rigging

When rigging the load:

- Before using a crane, check that it has been inspected and that its controls and safeguards are functioning properly;
- Before using lifting equipment, check that it has been inspected/rated and that it is free of defects;
- Use the correct rigging points and make sure that the rigging equipment is not subjected to uneven loads; Rig the load so that it cannot shift or tilt;
- Make sure not to twist rigging equipment such as chains or web slings.

### 4.4

#### Lifting

When lifting the load:

- Tension the rigging assembly at a low speed;
- Always keep an eye on the load;
- Lift the load vertically (not at an angle);
- Move the load as low as possible;  
Do not walk backwards when moving the load (tripping hazard).

### 4.5

#### Landing

When landing the load:

- Check that the load is in the right position;
- When landing the load, make sure that the rigging equipment will not become trapped;
- Lower the load gently;
- Once the load is in place, remove all rigging equipment.



When checking the crane, check its inspection sticker. Much like rigging equipment, it can be marked with the IMO colour system (International Maritime Organisation), as shown below. The disadvantage of this system is that it does not specify months.

**IMO colour system**

<b>Brown</b>	2010	2016	2022
<b>Blue</b>	2011	2017	2023
<b>Yellow</b>	2012	2018	2024
<b>Red</b>	2013	2019	2025
<b>Black</b>	2014	2020	2026
<b>Green</b>	2015	2021	2027

**4.6**

**Rejecting rigging equipment and tools**

Any rejected rigging equipment and tools must be taken out of service. To avoid situations in which rejected lifting devices and rigging equipment is used anyway, a clear separation must be made between usable and non-usable rigging equipment and tools. This can be done by using labels or storing them in a special room. If the rejected rigging equipment cannot be repaired, it must be rendered unusable, so that defective equipment or tools cannot be reused.

**4.7**

**Communication**

Before commencing the work, clear arrangements must be made with all those involved about communication. Only one person may give instructions to the operator. The operator must know who will be supervising the lift and only follow their instructions. Instructions can be given in two ways: the lift supervisor can use hand and arm signals, if they are in the operator's line of sight. If they are out of the operator's line of sight, the lift supervisor can use a camera or walkie-talkie.



4.8

**Hand and arm signals**

The Working Conditions Decree specifies standard hand and arm signals such as: left, right, lower, raise, etc.

### GEBRUIK HAND- EN ARMSEINEN

	<b>HIJSEN</b> Draai, met schuin opgeheven arm, de vuist in de pols.		<b>EEN KLEIN STUKJE</b> Bring beide handen op kleine afstand van elkaar, met de handpalmen naar elkaar toe.
	<b>VIEREN</b> Beweeg, met gestrekte arm, de hand flink op en neer. Beweeg zonodig de gehele arm.		<b>VLUCHT-VERANDERING</b> Geef met de hand aan waarheen de last moet worden verplaatst.
	<b>STOPPEN</b> Stopteken voor alle bewegingen van het hijswerktuig. Ook: aanhouden van de hijs.		<b>VLUCHT-VERANDERING</b> Geef met de hand aan waarheen de last moet worden verplaatst.
	<b>NOODSTOP</b> Noodstop voor alle bewegingen van het hijswerktuig.		<b>ZWENKEN</b> Geef de richting aan met de handen.

## 4.9

### Personal protective equipment

When working with lifting devices, you are obliged to wear at least a helmet and safety shoes. On top of that, you must comply with any specific rules that apply at the workplace in question.

i

#### Final tip

Safety starts with you. Don't just think of your own safety, but the safety of others too!









## MAIN OFFICE

### BLOM Opleidingen Hengelo

Adam Smithstraat 41  
7559 SW Hengelo

T 074 - 376 40 44

F 074 - 376 49 99

E [info@blomopleidingen.nl](mailto:info@blomopleidingen.nl)

► [blomopleidingen.nl](http://blomopleidingen.nl)



## ALL BRANCHES

- |   |  |  |
|---|--|--|
| <b>1 BLOM Opleidingen Alkmaar</b><br>Walruskoog 8<br>1822 BC Alkmaar            | <b>8 BLOM Opleidingen Emmen</b><br>Charles Darwinstraat 15<br>7825 AB Emmen    | <b>15 BLOM Opleidingen Schiedam</b><br>Fortunaweg 17<br>3113 AN Schiedam               |
| <b>2 BLOM Opleidingen Amersfoort</b><br>Zwaaiikom 31<br>3812 PS Amersfoort      | <b>9 BLOM Opleidingen Etten - Leur</b><br>Ambachtlaan 19<br>4871 ED Etten-Leur | <b>16 BLOM Opleidingen Son (bij Eindhoven)</b><br>Ekkersrijt 4509<br>5692 DN Eindhoven |
| <b>3 BLOM Opleidingen Amsterdam</b><br>Tijnmuiden 24<br>1046 AL Amsterdam       | <b>10 BLOM Opleidingen Geleen</b><br>Industrieweg 7c<br>6163 AH Geleen         | <b>17 BLOM Opleidingen Tilburg</b><br>Polluxstraat 3<br>5047 RA Tilburg                |
| <b>4 BLOM Opleidingen Assen</b><br>Australieweg 16<br>9407 TE Assen             | <b>11 BLOM Opleidingen Heerenveen</b><br>Energieaan 4<br>8447 ST Heerenveen    | <b>18 BLOM Opleidingen Venlo</b><br>Willem Barentszweg 4c<br>5928 LM Venlo             |
| <b>5 BLOM opleidingscentrum Barneveld</b><br>De Landweer 7<br>3771 LN Barneveld | <b>12 BLOM Opleidingen Heerlen</b><br>In de Cramer 14<br>6411 RS Heerlen       | <b>19 BLOM Opleidingen Wijchen</b><br>Bijsterhuizen 2010<br>6604 LJ Wijchen            |
| <b>6 BLOM Opleidingen Deventer</b><br>Solingenstraat 49<br>7421 ZR Deventer     | <b>13 BLOM Opleidingen Hengelo</b><br>Adam Smithstraat 41<br>7559 SW Hengelo   | <b>20 BLOM Opleidingen Zwolle</b><br>Popovstraat 11<br>8013 RK Zwolle                  |
| <b>7 BLOM Opleidingen Doetinchem</b><br>Havenstraat 120a<br>7005 AR Doetinchem  | <b>14 BLOM Opleidingen Houten</b><br>Bergveste 6-8<br>3992 DE Houten           | <b>21 BLOM Opleidingen Zoetermeer</b><br>Signaalrood 60<br>2718 SG Zoetermeer          |

**That's what BLOM is all about!**



**BLOM OPLEIDINGEN**